



Quote

DATE	QUOTE #
7/19/2022	2022-126

ISSUED TO	
SCOTT HOYNE ATTN: SCOTT HOYNE	
EMAIL: HOYNES50@GMAIL.COM TEL: 847-404-1316	
PROJECT NAME	COVERED BRIDGE - LONG GROVE, IL
REP	SFS

SHIP TO	
SHIP VIA	TBD
TERMS	TBD

LINE	ITEM	DESCRIPTION	QTY	UNIT PRICE	EXTENDED PRICE
1	SE-R/3310	SINGLE-EYE SINGLE DIRECTION DETECTION SYSTEM, SOURCE AND DETECTOR, VISIBLE RED, 120VAC	2	\$6,045.00	\$12,090.00
2	PMB-500	POLE MOUNT BRACKET	4	\$145.00	\$580.00
3	3601	VIBRATING HORN, 120VAC	2	\$450.00	\$900.00
4	CUSTOM WARNING SIGN	CUSTOM WARNING SIGN CONSISTING OF THE FOLLOWING: (1) STATIC SIGN, "OVERHEIGHT WHEN FLASHING" (1) FLASHING SIGN, "LOW BRIDGE", 8 LED AMBER,	2	\$2,000.00	\$4,000.00
5		STROBE/FLASH, 120VAC **NCNR (NON-CANCELABLE, NON-RETURNABLE)**			
6					
7					
8					
9					
10					
11					
12					

SHIPPING EXCLUDED UNLESS OTHERWISE INDICATED. ALL PRICES ARE IN US DOLLARS (USD) UNLESS STATED OTHERWISE. NCNR INDICATES ITEMS WHICH ARE NON-CANCELLABLE AND NON-RETURNABLE. REFER TO STANDARD TERMS AND CONDITIONS FOR DETAILS.

SUBTOTAL	\$17,570.00
SALES TAX	\$0.00
FEES	\$0.00
TOTAL	\$17,570.00

QUOTE VALID THRU 8/18/2022

STANDARD TERMS AND CONDITIONS

1. Definitions.
 - A. "Seller" refers to Trigg Industries, LLC.
 - B. "Buyer" refers to a purchaser of products or services from Trigg Industries, LLC.
 - C. "Domestic Purchase Orders" refers to an order from a Buyer located in the United States requesting products or Services from the Seller to be delivered to an address located in the United States.
 - D. "Origin" refers to Trigg Industries, LLC facility located at 716 Bluecrab Rd Ste B, Newport News, VA, 23606, USA.
2. Purchase Orders. All Domestic Purchase Orders require a signed and printed signature, customer title, and includes billing/shipping address.
3. Payment Terms.
 - A. All Domestic Purchase Orders require 25% prepayment prior to manufacturing start-up.
 - B. Non-Cancellable / Non-Returnable (NCNR) Products require 100% prepayment prior to manufacturing start-up.
 - C. Balance is NET 30 Days from date on invoice with approved credit for Domestic Purchase Orders only. Credit application sent upon request.
 - D. Payment in full is required prior to equipment being shipped if either of the following conditions are true:
 - i. Customer does not have credit satisfactory to Trigg Industries.
 - ii. Customer has not completed credit application.
 - E. Seller may change these credit terms if customer's financial condition changes.
4. Payment Methods. Seller accepts the following payment methods:
 - A. Credit Card – VISA, MasterCard, and American Express accepted with a valid billing address located in the United States. Refer to Section 5A for applicable fees.
 - B. Check – Accepted with a billing address in the United States.
 - C. Wire Transfer – Refer to Section 5B for applicable fees.
5. Fees.
 - A. Credit Card Fee – 4% Credit Card Fee will be added to invoice for each credit card transaction
 - B. Wire Transfer Fee - \$50.00 Wire Transfer Fee will be added to the invoice for each wire transfer
 - C. Late Payment Fee – 1.5% of invoice per month (18% annually)
6. Quotations.
 - A. Unless otherwise stated, prices issued in quotations are in United States Dollars (USD).
 - B. Unless otherwise stated, quotes are valid for 30 days from date of issue.

7. Delivery and Risk of Loss.
 - A. Shipping charges are FOB Origin and added to invoice unless charges are included with quote.
 - B. Risk or loss of goods in transit shall be with the Buyer.
 - C. Exact shipping charges will be invoiced at time of shipment.
8. Returned Merchandise. Returned merchandise without prior RMA Number (Return Merchandise Authorization), or COD's will not be accepted. Contact Seller to obtain RMA Number.
9. Lead Time. Standard equipment lead time is 4-6 weeks from receipt of Purchase Order, 25% Prepayment, and credit approval (if applicable), for manufacturing process to begin. Actual lead times may vary based on status of existing in-house orders, customization of orders, or volume.
10. Submittals. At the request of the customer, Trigg Industries generates submittals. When Submittals are approved by the Customer, Trigg Industries invoices the Customer for the 25% Purchase Order prepayment.
11. Seller's Rights Reserved and Arbitration.
 - A. Seller reserves the right to set the terms of sale
 - B. Any controversy between the Buyer and Seller shall be controlled by the laws of the State of Virginia, and the exclusive forum for filing of suit shall be in the Circuit Court for the City of Newport News, Virginia.
 - C. Any Purchase Order submitted by Buyer to Seller shall be deemed an offer to purchase, which can be accepted by Seller only by means of a written Acknowledgment. Any term and conditions in Buyer's Purchase Order that are in conflict with, differ from, or additions to, this Quotation or Seller's Acknowledgment shall be of no force and effect, shall not become part of any contract between Buyer and Seller and shall be deemed objected to by Seller without need of further notice of objection. By submitting a Purchase Order to Seller, Buyer agrees that the terms and conditions in Seller's Acknowledgment and this Quotation shall prevail over the terms and conditions in Buyer's Purchase Order. In the event of any discrepancy between Seller's Acknowledgment and this Quotation, Seller's Acknowledgment shall prevail.
12. Non-Cancellable / Non-Returnable (NCNR) Products:
 - A. Buyer hereby acknowledges that all orders for special, custom, value-added and other non-standard products ("NCNR Products") placed with Trigg Industries, LLC ("Seller") are non-cancellable and non-returnable. No return of NCNR Product(s) will be accepted by Seller unless defective and only with a returned material authorization number ("RMA Number") which shall be issued at the Seller's sole discretion. Seller will identify NCNR Products using "NCNR - NON-CANCELLABLE, NON-RETURNABLE" on Quote and Order Acknowledgement forms provided to Buyer.
 - B. Seller shall not be liable for failure to fulfill the purchase orders listed below or for delays in delivery due to causes beyond its reasonable control, including but not limited to acts of God, acts or omissions of the other party, acts or omissions of civil or military authority, Government party, acts or omissions of civil or military authority, Government priorities, material shortages, fire, strikes, floods, riots, war, acts of terrorism, pandemics, and delays in delivery or transportation. The time for performance of any such obligation shall be extended for the time period lost by reason of the delay.
 - C. Seller makes no warranty, express or implied with respect to NCNR Product(s) IN PARTICULAR, SELLER MAKES NO WARRANTY RESPECTING THE MERCHANTABILITY OF THE NCNR PRODUCTS OR THEIR SUITABILITY OR FITNESS FOR ANY PARTICULAR USE OR PURPOSE OR RESPECTING INFRINGEMENT. However, Seller will transfer to Buyer whatever transferable warranties and indemnities Seller receives from the manufacturer of the NCNR Products.

Buyer's Initials



D. BUYER SHALL NOT IN ANY EVENT BE ENTITLED TO, AND SELLER SHALL NOT BE LIABLE FOR DAMAGES, WHETHER INDIRECT, SPECIAL, INCIDENTAL OR CONSEQUENTIAL OF ANY NATURE INCLUDING, WITHOUT BEING LIMITED TO LOSS OF PROFIT, PROMOTIONAL OR MANUFACTURING EXPENSES, OVERHEAD, INJURY TO REPUTATION OR LOSS OF CUSTOMERS. BUYER'S RECOVERY FROM SELLER FOR ANY CLAIM SHALL NOT EXCEED BUYER'S PURCHASE PRICE FOR THE PRODUCTS IRRESPECTIVE OF THE NATURE OF THE CLAIM, WHETHER IN CONTRACT, TORT, WARRANTY OR OTHERWISE.

E. The parties agree that the conditions of sale of the NCNR Product(s) hereunder shall prevail, notwithstanding contrary or additional terms and conditions in any purchase order, acknowledgment, confirmation or any other form or document issued by either party effecting the purchase and/or sale of the NCNR Product(s).

13. **Warranty and Support.** Seller reserves the right to suspend warranty coverage and technical support if all invoices are not paid in full. Warranty coverage and technical support will resume once all of Buyer's invoices are paid in full.

14. **Hold Backs.** Seller does not recognize any "hold backs", milestone payments, percentage payments, or retainage a Buyer is obligated to by other stakeholders. All invoices must be paid in full as defined in Section 3.

Initial each page and complete sections below to accept the Terms and Conditions as outlined above:

_____	_____	_____
Company Name	Authorized Signature	Date
_____	_____	
Print Name	Title	
_____	_____	_____
Trigg Industries Representative Signature	Title	Date

SPECIFICATIONS

**MODEL # SE-R/3310
SINGLE EYE VISIBLE RED
OVER-HEIGHT VEHICLE DETECTION SYSTEM**

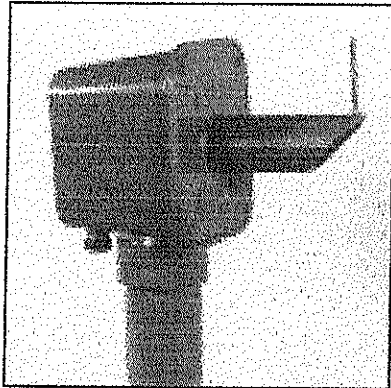

SOURCE

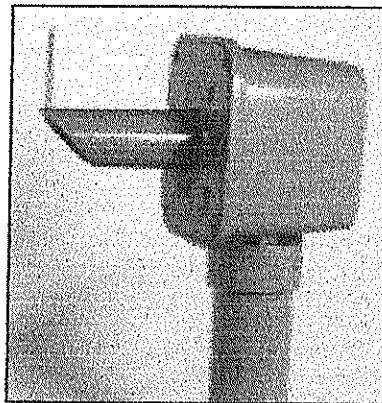

DETECTOR

SPECIFICATIONS:

MODEL	SE-R/3310	SE-R/3310 -F	SE-R/3310 -230	SE-R/3310 -F-230	SE-R/3310 -24	SE-R/3310 -F-24
OPERATING VOLTAGE	120 VAC, 50/60HZ		240 VAC, 50/60HZ		+24 VDC	
CURRENT - SOURCE	0.120A	0.120A	0.060A	0.060A	0.290A	0.290A
CURRENT - DETECTOR	0.215A	0.246A	0.108A	0.123A	0.390A	0.545A
ALARM OUTPUT	Form C, dry relay contact closure, contacts rated 240 VAC 10A, protected by 8A circuit breaker.					
ALARM TIME	Adjustable by customer from 1 to 30 seconds. Custom alarm times available.					
FAULT OPTION	Fault reporting relay contact opening upon loss of power, source/detector failure or if beam is blocked for approximately 13 seconds.					
FAULT OUTPUT		X		X		X
ELECTRONICS	Sensors are NEMA 6P enclosure rated. Electronic printed circuits for years of reliable operation.					
EFFECTS OF AMBIENT LIGHT	Sunlight immunity of 10,000 foot-candles.					
MINIMUM RANGE	6 feet (2 m).					
MAXIMUM RANGE	800 feet (244 m). Suggested maximum range 200 feet (61 m) to allow for bad weather and lens contamination.					
ALIGNMENT	Two LEDs and meter (GO-NOGO functions) provided for alignment. No special tools required.					

SPECIFICATIONS (CONT'D):

MODEL	SE-R/3310	SE-R/3310 -F	SE-R/3310 -230	SE-R/3310 -F-230	SE-R/3310 -24	SE-R/3310 -F-24
REACTION SPEED	1 to 75 MPH (1 to 121 km/h) for a 2.5 inch (6.25 cm) diameter object 1 inch (2.5 cm) above the detection height. Custom speed/size available.					
COUNTER	Records the number of activations.					
TEMPERATURE RANGE	-40° to +135° F (-40° to +57° C).					
ENVIRONMENTAL CONTROL	Internal thermostat controls air flow which reduces moisture and maintains internal temperature during cold weather.					
HOUSINGS	External housing is heavy ALMAG casting and sheet aluminum (not less than 1/8 inch or .318 cm thickness) for rugged durability and extended life. Cabinet design minimizes effects of vandalism and provides rigid mounting. Meets NEMA 3R intent.					
CONNECTORS	Source Cabinet: One 3/4" NPT hole accepts cord grip or conduit fitting. Detector Cabinet: One 3/4" NPT hole accepts cord grip or conduit fitting.					
MOUNTING	Pole-mountable using Model # PMB-500 bracket (available separately). Wall-mountable using Model # FSB-500 bracket (available separately). Pole-top mountable when using pole cap on Model # 3701 or 3702 poles. Optional Three-Axis Mount (Model # TGZ-M017) recommended in applications with cross slope or complex road profiles.					
DIMENSIONS	Source Cabinet: 15½ x 10 x 8¾ inches (39 x 25 x 22 cm). Detector Cabinet: 15½ x 10 x 8¾ inches (39 x 25 x 22 cm).					
SHIPPING WEIGHT	40 lbs (18 kg).					
WARRANTY	Standard 1-Year Full Warranty. Extended Warranty options available.					

ORDERING GUIDE – SOURCE AND DETECTOR:

MODEL #	DESCRIPTION
SE-R/3310	SINGLE-EYE SINGLE DIRECTION DETECTION SYSTEM, SOURCE AND DETECTOR, VISIBLE RED, 120VAC
SE-R/3310-230	SINGLE-EYE SINGLE DIRECTION DETECTION SYSTEM, SOURCE AND DETECTOR, VISIBLE RED, 230VAC
SE-R/3310-24	SINGLE-EYE SINGLE DIRECTION DETECTION SYSTEM, SOURCE AND DETECTOR, VISIBLE RED, 24VDC
SE-R/3310-F	SINGLE-EYE SINGLE DIRECTION DETECTION SYSTEM, SOURCE AND DETECTOR, VISIBLE RED, W/FAULT, 120VAC
SE-R/3310-F-230	SINGLE-EYE SINGLE DIRECTION DETECTION SYSTEM, SOURCE AND DETECTOR, VISIBLE RED, W/FAULT, 230VAC
SE-R/3310-F-24	SINGLE-EYE SINGLE DIRECTION DETECTION SYSTEM, SOURCE AND DETECTOR, VISIBLE RED, W/FAULT, 24VDC



ORDERING GUIDE – SOURCE UNIT ONLY:

MODEL #	DESCRIPTION
SE-R/3310S	SINGLE-EYE SINGLE DIRECTION DETECTION SYSTEM, SOURCE UNIT ONLY, VISIBLE RED, 120VAC
SE-R/3310S-230	SINGLE-EYE SINGLE DIRECTION DETECTION SYSTEM, SOURCE UNIT ONLY, VISIBLE RED, 230VAC
SE-R/3310S-24	SINGLE-EYE SINGLE DIRECTION DETECTION SYSTEM, SOURCE UNIT ONLY, VISIBLE RED, 24VDC
SE-R/3310FS	SINGLE-EYE SINGLE DIRECTION DETECTION SYSTEM, SOURCE UNIT ONLY, VISIBLE RED, W/FAULT, 120VAC
SE-R/3310FS-230	SINGLE-EYE SINGLE DIRECTION DETECTION SYSTEM, SOURCE UNIT ONLY, VISIBLE RED, W/FAULT, 230VAC
SE-R/3310FS-24	SINGLE-EYE SINGLE DIRECTION DETECTION SYSTEM, SOURCE UNIT ONLY, VISIBLE RED, W/FAULT, 24VDC

ORDERING GUIDE – DETECTOR UNIT ONLY:

MODEL #	DESCRIPTION
SE-R/3310D	SINGLE-EYE SINGLE DIRECTION DETECTION SYSTEM, DETECTOR UNIT ONLY, VISIBLE RED, 120VAC
SE-R/3310D-230	SINGLE-EYE SINGLE DIRECTION DETECTION SYSTEM, DETECTOR UNIT ONLY, VISIBLE RED, 230VAC
SE-R/3310D-24	SINGLE-EYE SINGLE DIRECTION DETECTION SYSTEM, DETECTOR UNIT ONLY, VISIBLE RED, 24VDC
SE-R/3310FD	SINGLE-EYE SINGLE DIRECTION DETECTION SYSTEM, DETECTOR UNIT ONLY, VISIBLE RED, W/FAULT, 120VAC
SE-R/3310FD-230	SINGLE-EYE SINGLE DIRECTION DETECTION SYSTEM, DETECTOR UNIT ONLY, VISIBLE RED, W/FAULT, 230VAC
SE-R/3310FD-24	SINGLE-EYE SINGLE DIRECTION DETECTION SYSTEM, DETECTOR UNIT ONLY, VISIBLE RED, W/FAULT, 24VDC

OPTIONAL ACCESSORIES:

MODEL #	DESCRIPTION
PMB-500	POLE MOUNT BRACKET
TGZ-M017	THREE-AXIS MOUNT
FSB-500	FLAT SURFACE BRACKET
USC-1000	UNIVERSAL SYSTEM CONTROLLER (PROVIDES LOGGING AND REMOTE NOTIFICATIONS)
TG-CAM-1010	NETWORK CAMERA (PROVIDES SNAPSHOT IMAGES AND VIDEO RECORDINGS)

Additional accessories and warning devices are available from Trigg Industries LLC.
Contact sales@triggindustries.com for details.

SPECIFICATIONS

**MODEL # PMB-500
POLE MOUNT BRACKET**

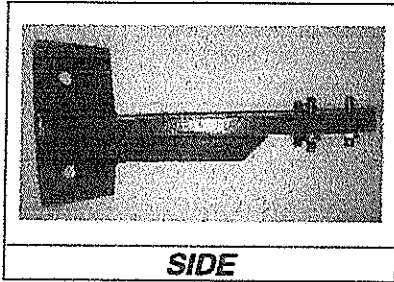

SIDE

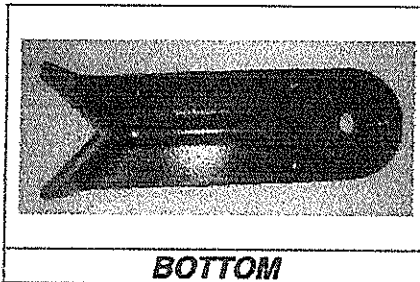

BOTTOM

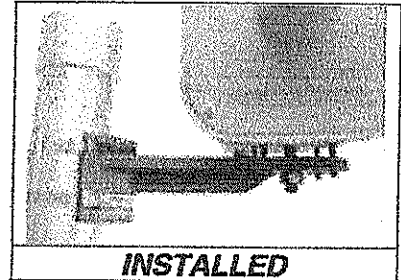

INSTALLED

ADJUSTMENT	Pan 270°, Pitch ± 15°, Roll ± 25°
DIMENSIONS	5 H X 3.5 W X 11 L inch (13 H X 9 W X 28 L cm)
CONSTRUCTION	Heavy ALMAG casting
FINISH	Light gray enamel
ATTACHMENT	Stainless steel bands or customer provided bolts. Adapts to any pole ≥ 3 inches diameter.
SHIPPING WEIGHT	2.5 lbs (1.2 kg) each. Two required per system.

SPECIFICATIONS

MODEL # 3601 (AC MODELS) VIBRATING HORN

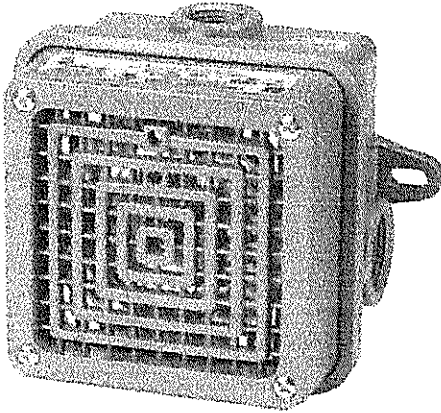

SPECIFICATIONS:

MODEL	3601	3601-230
OPERATING VOLTAGE	120 VAC, 50/60Hz	240 VAC, 50/60Hz
CURRENT	0.22 A	0.09 A
POWER	26.4 VA	21.6 VA
OUTPUT AT 10 FT (3.05 m)	100 dB(A)	
OUTPUT AT 30 FT (9.15 m)	90.46 dB(A)	
OUTPUT AT 70 FT (21.34 m)	83.1 dB(A)	
OUTPUT AT 100 FT (30.48 m)	80 dB(A)	
MATERIAL AND FINISH	Horn housing: Die-cast aluminum, gray enamel finish. Horn mounting box: Die-cast aluminum, gray enamel finish.	
ADJUSTMENT	Volume adjustment using set screw located on grille front	
DIMENSIONS	4.53" x 4.53" x 3.66" (115.1 mm x 115.1 mm x 93.0 mm)	
MOUNTING	Mounts on 1/2" or 3/4" NPT conduit, or to any flat surface	
TEMP. RANGE	-65°F to +150°F (-54°C to +66°C)	
ENVIRONMENTAL	NEMA 4X / IP65 / IP69K	
CERTIFICATIONS	UL and cUL Listed	
NET WEIGHT	2.7 lbs (1.2 kg)	
SHIPPING WEIGHT	2.8 lbs (1.2 kg)	

DIMENSIONS:

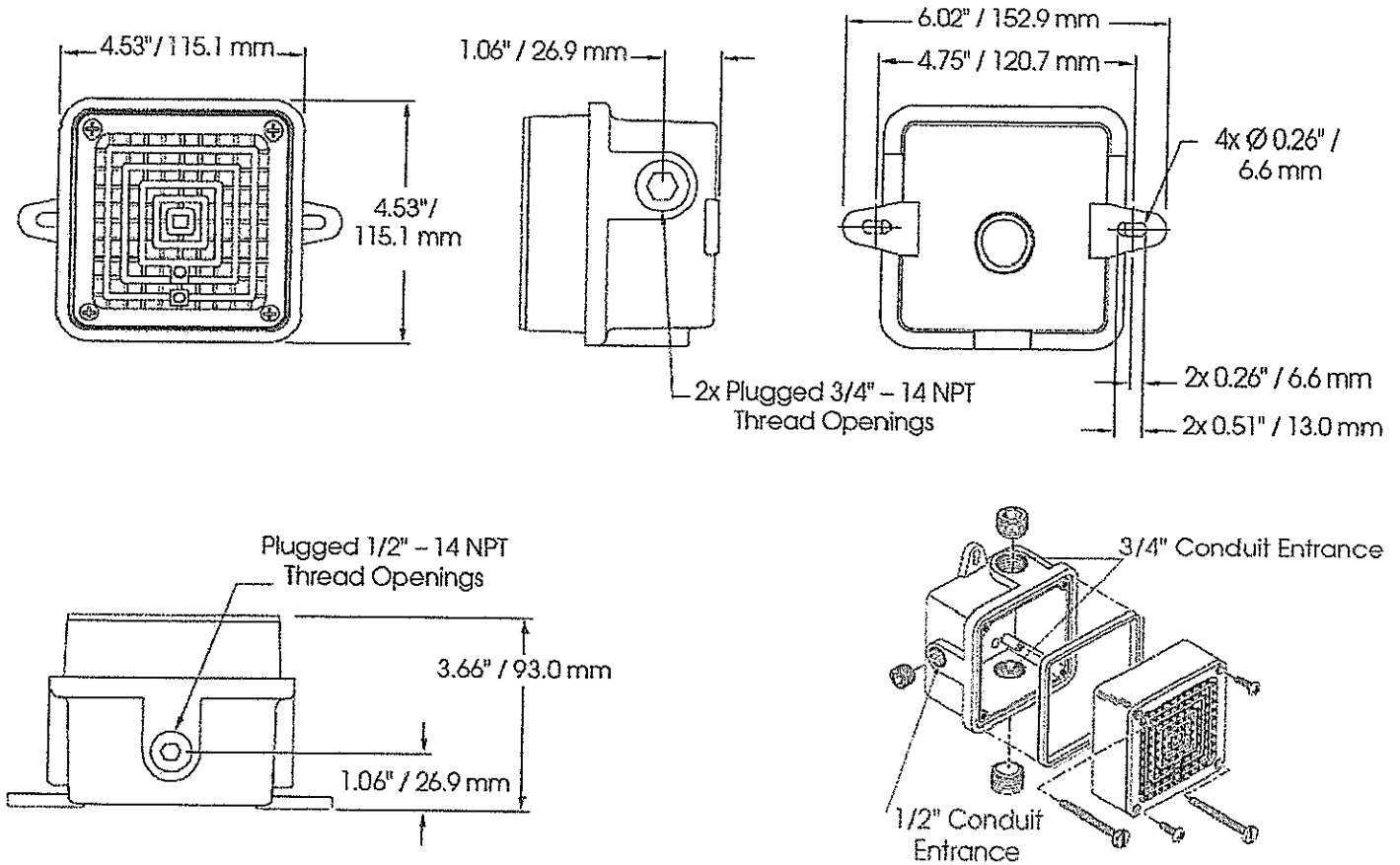

OPTIONAL ACCESSORIES:

MODEL #	DESCRIPTION
USC-1000	UNIVERSAL SYSTEM CONTROLLER (PROVIDES LOGGING AND REMOTE NOTIFICATIONS)
TG-CAM-1010	NETWORK CAMERA (PROVIDES SNAPSHOT IMAGES AND VIDEO RECORDINGS)

Additional accessories and warning devices are available from Trigg Industries LLC.
Contact sales@triggindustries.com for details.

ALL PICTURES SHOWN ARE FOR ILLUSTRATION PURPOSE ONLY.
ACTUAL PRODUCT IMAGE MAY VARY DUE TO PRODUCT ENHANCEMENT.

LED SignLITE Signs

Sign LITE Warning System

*Easy to fit to existing sign, no AC required,
\$ 0.00 cost to operate.*

Description

Rigid aluminum structure with reinforced steel corners mounts to standard traffic sign with either 3M VHB tape or self tapping screws. LED warning system is embedded in weather tight epoxy. Hi visibility Luxeon Rebel LED's feature lens to greatly increase viewing distance. NEMA Enclosure to house Battery, Charge & Flash Control. Solar Panel and Pole Mount Hardware. Solar power allows installation where no power line is available.



Luxeon Rebel LED's

8 x 110 Lumen Luxeon Rebel Amber LED's
Total Luminous Flux = 880 lumen.
Viewing Angle 30 degrees
Luminous Intensity @ 4 feet = 110 Fc.
Meets SAE Standard J595.
Increased visibility at greater distance.

Most Common Sign Types :

- W11-2, Pedestrian Crossing
- Reduce Speed Ahead
- W3-3, Signal Ahead
- W12-2, Overheight "X"

ELECTRICAL

Enclosure with Flanges for pole mounting.
Includes Strobe2 Power Supply.
7 Selectable Flash Patterns.
(Flash Rate 55 fpm. Single Pulse DC standard, AC available).
20 Watt Solar Panel .
12 Amp Charge Controller.
15 Ahr Rechargeable Battery.

PHYSICAL

Sign - 3M Diamond Grade Reflective Sheet (FYG or YEL)
on Aluminum 0.08 Type 5052.
Light Channel - Extruded Aluminum 6105-T5.
Steel Reinforced corners.
3M VHB (Very High Bond) Tape.
(8) 6-32 x 3/8" Self Tap S/S Mounting Screws.
Light Channel Color - Black.
LED's embedded in UV resistant Clear Epoxy.>200 deg.F.
Weather tight to IP68.

30 in. Sign , Weight 8 lbs.
Dimensions : 30" x 30" x 1/2"D.
36 in. Sign , Weight 10 lbs.
Frame Dimensions : 36" x 36" x 1/2"D.
3 Year warranty (SignLITE), 1 Year (Battery).



LED SignLITE Signs

SOLAR 24 / 7 PACKAGE

Allows round the clock operation for 24 hrs / 7 day .

SOLAR TIME CLOCK PACKAGE

Turns sign on based on Time Clock program hours.

SOLAR PUSHBUTTON or SmartWALK SENSOR INPUT PACKAGE

Turns sign on for user selectable period when input is sensed from either Pedestrian pushbutton, detector or other input.

(PB or Sensor not included)

SYNC OPTION

Allows two signs (usually on opposite sides of street) to turn on together upon one being activated.

AC POWER OPTION

AC/DC power supply provided for AC line operation.

* Post or Pole not included.



Solar Panel - Sunwize or equal OEM Series.

Solar Panel Side of pole Mount.

Control Housing / Cabinet.

Charge Controller - Morningstar

Battery - Universal Battery or Deka

Timer Relay - Fuji or Seco

Flasher / Strobe - M-SYSTEMS INC.

Power Supply - Meanwell.

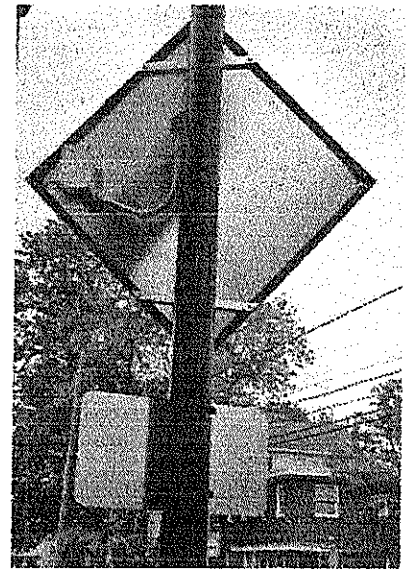

Type S1-1



Quote

DATE	QUOTE #
7/21/2022	2022-128

ISSUED TO SCOTT HOYNE ATTN: SCOTT HOYNE EMAIL: HOYNES50@GMAIL.COM TEL: 847-404-1316		SHIP TO	
PROJECT NAME	COVERED BRIDGE - LONG GROVE, IL (SOLAR/WIRELESS)	SHIP VIA	TBD
REP	SFS	TERMS	TBD

LINE	ITEM	DESCRIPTION	QTY	UNIT PRICE	EXTENDED PRICE
1	SE-R/3310-24	SINGLE-EYE SINGLE DIRECTION DETECTION SYSTEM, SOURCE AND DETECTOR, VISIBLE RED, 24VDC	2	\$6,045.00	\$12,090.00
2	PMB-500	POLE MOUNT BRACKET	4	\$145.00	\$580.00
3	3601-24	VIBRATING HORN, 24VDC	2	\$450.00	\$900.00
4	CUSTOM WARNING SIGN	CUSTOM WARNING SIGN CONSISTING OF THE FOLLOWING: (1) STATIC SIGN, "OVERHEIGHT WHEN FLASHING" (1) FLASHING SIGN, "LOW BRIDGE", 8 LED AMBER,	2	\$2,000.00	\$4,000.00
5		STROBE/FLASH, 12VDC **NCNR (NON-CANCELABLE, NON-RETURNABLE)**			
6	RFL-1008-24	RADIO FREQUENCY LINK (ALARM/FAULT WARNING) GATEWAY AND NODE, MEDIUM RANGE LINK, 6MI, LOS, SPREAD SPECTRUM, 24VDC	2	\$7,500.00	\$15,000.00
7	CUSTOM SOLAR 150W	CUSTOM SOLAR ASSEMBLY, SEPCO-SEPA100-M-ALC18/DCDC, 150 WATT, 112 AMP HR BATTERY ASSEMBLY, ALC CONTROLLER, 12VDC TO 24VDC CONVERTER **NCNR**	6	\$2,500.00	\$15,000.00
8					
9					
10					
11					
12					

SHIPPING EXCLUDED UNLESS OTHERWISE INDICATED. ALL PRICES ARE IN US DOLLARS (USD) UNLESS STATED OTHERWISE. NCNR INDICATES ITEMS WHICH ARE NON-CANCELLABLE AND NON-RETURNABLE. REFER TO STANDARD TERMS AND CONDITIONS FOR DETAILS.

SUBTOTAL	\$47,570.00
SALES TAX	\$0.00
FEES	\$0.00
TOTAL	\$47,570.00

QUOTE VALID THRU 8/20/2022

STANDARD TERMS AND CONDITIONS

1. Definitions.
 - A. "Seller" refers to Trigg Industries, LLC.
 - B. "Buyer" refers to a purchaser of products or services from Trigg Industries, LLC.
 - C. "Domestic Purchase Orders" refers to an order from a Buyer located in the United States requesting products or Services from the Seller to be delivered to an address located in the United States.
 - D. "Origin" refers to Trigg Industries, LLC facility located at 716 Bluecrab Rd Ste B, Newport News, VA, 23606, USA.
2. Purchase Orders. All Domestic Purchase Orders require a signed and printed signature, customer title, and includes billing/shipping address.
3. Payment Terms.
 - A. All Domestic Purchase Orders require 25% prepayment prior to manufacturing start-up.
 - B. Non-Cancellable / Non-Returnable (NCNR) Products require 100% prepayment prior to manufacturing start-up.
 - C. Balance is NET 30 Days from date on invoice with approved credit for Domestic Purchase Orders only. Credit application sent upon request.
 - D. Payment in full is required prior to equipment being shipped if either of the following conditions are true:
 - i. Customer does not have credit satisfactory to Trigg Industries.
 - ii. Customer has not completed credit application.
 - E. Seller may change these credit terms if customer's financial condition changes.
4. Payment Methods. Seller accepts the following payment methods:
 - A. Credit Card – VISA, MasterCard, and American Express accepted with a valid billing address located in the United States. Refer to Section 5A for applicable fees.
 - B. Check – Accepted with a billing address in the United States.
 - C. Wire Transfer – Refer to Section 5B for applicable fees.
5. Fees.
 - A. Credit Card Fee – 4% Credit Card Fee will be added to invoice for each credit card transaction
 - B. Wire Transfer Fee - \$50.00 Wire Transfer Fee will be added to the invoice for each wire transfer
 - C. Late Payment Fee – 1.5% of invoice per month (18% annually)
6. Quotations.
 - A. Unless otherwise stated, prices issued in quotations are in United States Dollars (USD).
 - B. Unless otherwise stated, quotes are valid for 30 days from date of issue.

7. Delivery and Risk of Loss.
 - A. Shipping charges are FOB Origin and added to invoice unless charges are included with quote.
 - B. Risk or loss of goods in transit shall be with the Buyer.
 - C. Exact shipping charges will be invoiced at time of shipment.
8. Returned Merchandise. Returned merchandise without prior RMA Number (Return Merchandise Authorization), or COD's will not be accepted. Contact Seller to obtain RMA Number.
9. Lead Time. Standard equipment lead time is 4-6 weeks from receipt of Purchase Order, 25% Prepayment, and credit approval (if applicable), for manufacturing process to begin. Actual lead times may vary based on status of existing in-house orders, customization of orders, or volume.
10. Submittals. At the request of the customer, Trigg Industries generates submittals. When Submittals are approved by the Customer, Trigg Industries invoices the Customer for the 25% Purchase Order prepayment.
11. Seller's Rights Reserved and Arbitration.
 - A. Seller reserves the right to set the terms of sale
 - B. Any controversy between the Buyer and Seller shall be controlled by the laws of the State of Virginia, and the exclusive forum for filing of suit shall be in the Circuit Court for the City of Newport News, Virginia.
 - C. Any Purchase Order submitted by Buyer to Seller shall be deemed an offer to purchase, which can be accepted by Seller only by means of a written Acknowledgment. Any term and conditions in Buyer's Purchase Order that are in conflict with, differ from, or additions to, this Quotation or Seller's Acknowledgment shall be of no force and effect, shall not become part of any contract between Buyer and Seller and shall be deemed objected to by Seller without need of further notice of objection. By submitting a Purchase Order to Seller, Buyer agrees that the terms and conditions in Seller's Acknowledgment and this Quotation shall prevail over the terms and conditions in Buyer's Purchase Order. In the event of any discrepancy between Seller's Acknowledgment and this Quotation, Seller's Acknowledgment shall prevail.
12. Non-Cancellable / Non-Returnable (NCNR) Products:
 - A. Buyer hereby acknowledges that all orders for special, custom, value-added and other non-standard products ("NCNR Products") placed with Trigg Industries, LLC ("Seller") are non-cancellable and non-returnable. No return of NCNR Product(s) will be accepted by Seller unless defective and only with a returned material authorization number ("RMA Number") which shall be issued at the Seller's sole discretion. Seller will identify NCNR Products using "NCNR - NON-CANCELLABLE, NON-RETURNABLE" on Quote and Order Acknowledgement forms provided to Buyer.
 - B. Seller shall not be liable for failure to fulfill the purchase orders listed below or for delays in delivery due to causes beyond its reasonable control, including but not limited to acts of God, acts or omissions of the other party, acts or omissions of civil or military authority, Government party, acts or omissions of civil or military authority, Government priorities, material shortages, fire, strikes, floods, riots, war, acts of terrorism, pandemics, and delays in delivery or transportation. The time for performance of any such obligation shall be extended for the time period lost by reason of the delay.
 - C. Seller makes no warranty, express or implied with respect to NCNR Product(s) IN PARTICULAR, SELLER MAKES NO WARRANTY RESPECTING THE MERCHANTABILITY OF THE NCNR PRODUCTS OR THEIR SUITABILITY OR FITNESS FOR ANY PARTICULAR USE OR PURPOSE OR RESPECTING INFRINGEMENT. However, Seller will transfer to Buyer whatever transferable warranties and indemnities Seller receives from the manufacturer of the NCNR Products.

Buyer's Initials



D. BUYER SHALL NOT IN ANY EVENT BE ENTITLED TO, AND SELLER SHALL NOT BE LIABLE FOR DAMAGES, WHETHER INDIRECT, SPECIAL, INCIDENTAL OR CONSEQUENTIAL OF ANY NATURE INCLUDING, WITHOUT BEING LIMITED TO LOSS OF PROFIT, PROMOTIONAL OR MANUFACTURING EXPENSES, OVERHEAD, INJURY TO REPUTATION OR LOSS OF CUSTOMERS. BUYER'S RECOVERY FROM SELLER FOR ANY CLAIM SHALL NOT EXCEED BUYER'S PURCHASE PRICE FOR THE PRODUCTS IRRESPECTIVE OF THE NATURE OF THE CLAIM, WHETHER IN CONTRACT, TORT, WARRANTY OR OTHERWISE.

E. The parties agree that the conditions of sale of the NCNR Product(s) hereunder shall prevail, notwithstanding contrary or additional terms and conditions in any purchase order, acknowledgment, confirmation or any other form or document issued by either party effecting the purchase and/or sale of the NCNR Product(s).

13. Warranty and Support. Seller reserves the right to suspend warranty coverage and technical support if all invoices are not paid in full. Warranty coverage and technical support will resume once all of Buyer's invoices are paid in full.

14. Hold Backs. Seller does not recognize any "hold backs", milestone payments, percentage payments, or retainage a Buyer is obligated to by other stakeholders. All invoices must be paid in full as defined in Section 3.

Initial each page and complete sections below to accept the Terms and Conditions as outlined above:

_____	_____	_____
Company Name	Authorized Signature	Date
_____	_____	
Print Name	Title	
_____	_____	_____
Trigg Industries Representative Signature	Title	Date



Quote

DATE	QUOTE #
3/1/2021	2021-041

ISSUED TO SCOTT HOYNE E-MAIL: HOYNESS0@GMAIL.COM TEL: 847-404-1316
--

SHIP TO

REP	PROJECT NAME
SFS	COVERED BRIDGE - LONG GROVE, IL

LINE	ITEM	DESCRIPTION	QTY	UNIT PRICE	TOTAL PRICE
		OVER-HEIGHT VEHICLE DETECTION SYSTEM (OHVDS)			
1	SE-R/3310	SINGLE-EYE SINGLE DIRECTION DETECTION SYSTEM, SOURCE AND DETECTOR, VISIBLE RED, 120VAC	1	\$5,427.00	\$5,427.00
2	PMB-500	POLE MOUNT BRACKET	2	\$124.00	\$248.00
		AUDIBLE WARNING DEVICE			
3	3601	VIBRATING HORN, 120VAC	1	\$332.00	\$332.00
		VISUAL WARNING DEVICE			
4	CUSTOM WARNING SIGNS	CUSTOM WARNING SIGN CONSISTING OF THE FOLLOWING: (1) STATIC SIGN, "OVERHEIGHT WHEN FLASHING" (1) FLASHING SIGN, "LOW BRIDGE", 8 LED AMBER, STROBE/FLASH, 120VAC **NCNR (NON-CANCELABLE, NON-RETURNABLE)**	1	\$1,500.00	\$1,500.00

REFER TO STANDARD TERMS AND CONDITIONS. POWER/COMMUNICATION CABLES ARE THE RESPONSIBILITY OF THE CUSTOMER (AVAILABLE AT ADDITIONAL COST). SHIPPING CHARGES ARE FOB NEWPORT NEWS, VA. RISK OR LOSS OF GOODS IN TRANSIT SHALL BE WITH THE BUYER. SHIPPING EXCLUDED UNLESS OTHERWISE INDICATED. EXACT SHIPPING CHARGES WILL BE INVOICED AT TIME OF SHIPMENT. CELLULAR DATA SERVICE IS THE RESPONSIBILITY OF THE END-USER. ALL PRICES ARE IN US DOLLARS (USD) UNLESS STATED OTHERWISE.

Sub Total (USD)	\$7,507.00
Sales Tax (USD)	\$0.00
Est. Shipping (USD)	(EXCLUDED)
Total (USD)	\$7,507.00

TRIGG INDUSTRIES, LLC
 716 BLUECRAB ROAD, SUITE B
 NEWPORT NEWS, VA 23606-2678, USA

TEL: 757-223-7522
 FAX: 757-223-7317

SALES@TRIGGINDUSTRIES.COM
 WWW.TRIGGINDUSTRIES.COM

STANDARD TERMS AND CONDITIONS

1. Definitions.
 - A. "Seller" refers to Trigg Industries, LLC.
 - B. "Buyer" refers to a purchaser of products or services from Trigg Industries, LLC.
 - C. "Domestic Purchase Orders" refers to an order from a Buyer located in the United States requesting products or Services from the Seller to be delivered to an address located in the United States.
2. Purchase Orders. All Domestic Purchase Orders require a signed and printed signature, customer title, and includes billing/shipping address.
3. Payment Terms.
 - A. All Domestic Purchase Orders require 25% prepayment prior to manufacturing start-up.
 - B. Non-Cancellable / Non-Returnable (NCNR) Products require 100% prepayment prior to manufacturing start-up.
 - C. Balance is NET 30 Days from date on invoice with approved credit for Domestic Purchase Orders only. Credit application sent upon request.
 - D. Seller may change these credit terms if customer's financial condition changes. If a customer does not have credit satisfactory to Trigg Industries, payment in full is required prior to equipment being shipped.
4. Payment Methods. Seller accepts the following payment methods:
 - A. Credit Card – VISA, MasterCard, and American Express accepted with a valid billing address located in the United States. Refer to Section 5A for applicable fees.
 - B. Check – Accepted with a billing address in the United States.
 - C. Wire Transfer – Refer to Section 5B for applicable fees.
5. Fees.
 - A. Credit Card Fee – 4% Credit Card Fee will be added to invoice for each credit card transaction
 - B. Wire Transfer Fee - \$50.00 Wire Transfer Fee will be added to the invoice for each wire transfer
 - C. Late Payment Fee – 1.5% of invoice per month (18% annually)
6. Quotations.
 - A. Unless otherwise stated, prices issued in quotations are in United States Dollars (USD).
 - B. Unless otherwise stated, quotes are valid for 6 months from date of issue.
7. Delivery and Risk of Loss.
 - A. Shipping charges are FOB Newport News, VA and added to invoice unless charges are included with quote.
 - B. Risk or loss of goods in transit shall be with the Buyer.
 - C. Exact shipping charges will be invoices at time of shipment.

Buyer's Initials

8. **Returned Merchandise.** Returned merchandise without prior RMA Number (Return Merchandise Authorization), or COD's will not be accepted. Contact Seller to obtain RMA Number.
9. **Lead Time.** Standard equipment lead time is 4-6 weeks from receipt of Purchase Order, 25% Prepayment, and credit approval (if applicable), for manufacturing process to begin. Actual lead times may vary based on status of existing in-house orders, customization of orders, or volume.
10. **Submittals.** At the request of the customer, Trigg Industries generates submittals. When Submittals are approved by the Customer, Trigg Industries invoices the Customer for the 25% Purchase Order prepayment.
11. **Seller's Rights Reserved and Arbitration.**
 - A. Seller reserves the right to set the terms of sale
 - B. Any controversy between the Buyer and Seller shall be controlled by the laws of the State of Virginia, and the exclusive forum for filing of suit shall be in the Circuit Court for the City of Newport News, Virginia.
 - C. Any Purchase Order submitted by Buyer to Seller shall be deemed an offer to purchase, which can be accepted by Seller only by means of a written Acknowledgment. Any term and conditions in Buyer's Purchase Order that are in conflict with, differ from, or additions to, this Quotation or Seller's Acknowledgment shall be of no force and effect, shall not become part of any contract between Buyer and Seller and shall be deemed objected to by Seller without need of further notice of objection. By submitting a Purchase Order to Seller, Buyer agrees that the terms and conditions in Seller's Acknowledgment and this Quotation shall prevail over the terms and conditions in Buyer's Purchase Order. In the event of any discrepancy between Seller's Acknowledgment and this Quotation, Seller's Acknowledgment shall prevail.
12. **Non-Cancellable / Non-Returnable (NCNR) Products:**
 - A. Buyer hereby acknowledges that all orders for special, custom, value-added and other non-standard products ("NCNR Products") placed with Trigg Industries, LLC ("Seller") are non-cancellable and non-returnable. No return of NCNR Product(s) will be accepted by Seller unless defective and only with a returned material authorization number ("RMA Number") which shall be issued at the Seller's sole discretion. Seller will identify NCNR Products using "NCNR - NON-CANCELLABLE, NON-RETURNABLE" on Quote and Order Acknowledgement forms provided to Buyer.
 - B. Seller shall not be liable for failure to fulfill the purchase orders listed below or for delays in delivery due to causes beyond its reasonable control, including but not limited to acts of God, acts or omissions of the other party, acts or omissions of civil or military authority, Government party, acts or omissions of civil or military authority, Government priorities, material shortages, fire, strikes, floods, riots, war, acts of terrorism, pandemics, and delays in delivery or transportation. The time for performance of any such obligation shall be extended for the time period lost by reason of the delay.
 - C. Seller makes no warranty, express or implied with respect to NCNR Product(s) IN PARTICULAR, SELLER MAKES NO WARRANTY RESPECTING THE MERCHANTABILITY OF THE NCNR PRODUCTS OR THEIR SUITABILITY OR FITNESS FOR ANY PARTICULAR USE OR PURPOSE OR RESPECTING INFRINGEMENT. However, Seller will transfer to Buyer whatever transferable warranties and indemnities Seller receives from the manufacturer of the NCNR Products.
 - D. BUYER SHALL NOT IN ANY EVENT BE ENTITLED TO, AND SELLER SHALL NOT BE LIABLE FOR DAMAGES, WHETHER INDIRECT, SPECIAL, INCIDENTAL OR CONSEQUENTIAL OF ANY NATURE INCLUDING, WITHOUT BEING LIMITED TO LOSS OF PROFIT, PROMOTIONAL OR MANUFACTURING EXPENSES, OVERHEAD, INJURY TO REPUTATION OR LOSS OF CUSTOMERS. BUYER'S RECOVERY FROM SELLER FOR ANY CLAIM SHALL NOT EXCEED BUYER'S PURCHASE PRICE FOR THE PRODUCTS IRRESPECTIVE OF THE NATURE OF THE CLAIM, WHETHER IN CONTRACT, TORT, WARRANTY OR OTHERWISE.
 - E. The parties agree that the conditions of sale of the NCNR Product(s) hereunder shall prevail, notwithstanding contrary or additional terms and conditions in any purchase order, acknowledgment, confirmation or any other form or document issued by either party effecting the purchase and/or sale of the NCNR Product(s).

Buyer's Initials



- 13. **Warranty and Support.** Seller reserves the right to suspend warranty coverage and technical support if all invoices are not paid in full. Warranty coverage and technical support will resume once all of Buyer's invoices are paid in full.
- 14. **Hold Backs.** Seller does not recognize any "hold backs", milestone payments, percentage payments, or retainage a Buyer is obligated to by other stakeholders. All invoices must be paid in full as defined in Section 3.

Initial each page and complete sections below to accept the Terms and Conditions as outlined above:

_____	_____	_____
Company Name	Authorized Signature	Date
_____	_____	
Print Name	Title	
_____	_____	_____
Trigg Industries Representative Signature	Title	Date

SPECIFICATIONS

MODEL # SE-R/3310
SINGLE EYE VISIBLE RED
OVER-HEIGHT VEHICLE DETECTION SYSTEM

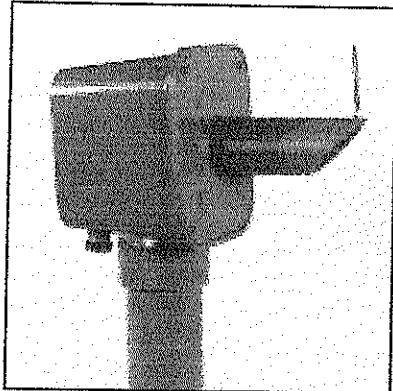

SOURCE

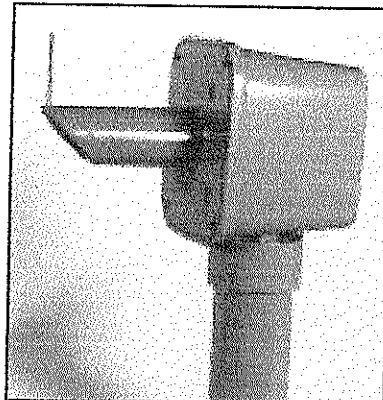

DETECTOR

MODEL	SE-R/3310	SE-R/3310 -F	SE-R/3310 -230	SE-R/3310 -F-230	SE-R/3310 -24	SE-R/3310 -F-24
OPERATING VOLTAGE	120 VAC, 50/60HZ		240 VAC, 50/60HZ		+24 VDC	
CURRENT - SOURCE	0.120A	0.120A	0.060A	0.060A	0.290A	0.290A
CURRENT - DETECTOR	0.215A	0.246A	0.108A	0.123A	0.390A	0.545A
ALARM OUTPUT	Form C, dry relay contact closure, contacts rated 240 VAC 10A, protected by 8A circuit breaker.					
ALARM TIME	Adjustable by customer from 1 to 30 seconds. Custom alarm times available.					
FAULT OPTION	Fault reporting relay contact opening upon loss of power, source/detector failure or if beam is blocked for approximately 13 seconds.					
FAULT OUTPUT		X		X		X
ELECTRONICS	Sensors are NEMA 6P enclosure rated. Electronic printed circuits for years of reliable operation.					
EFFECTS OF AMBIENT LIGHT	Sunlight immunity of 10,000 foot-candles.					
MINIMUM RANGE	6 feet (2 m).					
MAXIMUM RANGE	800 feet (244 m). Suggested maximum range 200 feet (61 m) to allow for bad weather and lens contamination.					
ALIGNMENT	Two LEDs and meter (GO-NOGO functions) provided for alignment. No special tools required.					

SPECIFICATIONS (CONT'D):

MODEL	SE-R/3310	SE-R/3310 -F	SE-R/3310 -230	SE-R/3310 -F-230	SE-R/3310 -24	SE-R/3310 -F-24
REACTION SPEED	1 to 75 MPH (1 to 121 km/h) for a 2.5 inch (6.25 cm) diameter object 1 inch (2.5 cm) above the detection height. Custom speed/size available.					
COUNTER	Records the number of activations.					
TEMPERATURE RANGE	-40° to +135° F (-40° to +57° C).					
ENVIRONMENTAL CONTROL	Internal thermostat controls air flow which reduces moisture and maintains internal temperature during cold weather.					
HOUSINGS	External housing is heavy ALMAG casting and sheet aluminum (not less than 1/8 inch or .318 cm thickness) for rugged durability and extended life. Cabinet design minimizes effects of vandalism and provides rigid mounting. Meets NEMA 3R intent.					
CONNECTORS	Source Cabinet: One 3/4" NPT hole accepts cord grip or conduit fitting. Detector Cabinet: One 3/4" NPT hole accepts cord grip or conduit fitting.					
MOUNTING	Pole-mountable using Model # PMB-500 bracket (available separately). Wall-mountable using Model # FSB-500 bracket (available separately). Pole-top mountable when using pole cap on Model # 3701 or 3702 poles. Optional Three-Axis Mount (Model # TGZ-M017) recommended in applications with cross slope or complex road profiles.					
DIMENSIONS	Source Cabinet: 15½ x 10 x 8¾ inches (39 x 25 x 22 cm).				20 lbs	
SHIPPING WEIGHT	Detector Cabinet: 15½ x 10 x 8¾ inches (39 x 25 x 22 cm).				20 lbs	
WARRANTY	Standard 1-Year Full Warranty. Extended Warranty options available.					

OPTIONAL ACCESSORIES:

MODEL #	DESCRIPTION
PMB-500	Pole Mount Bracket
TGZ-M017	Three-Axis Mount
FSB-500	Flat Surface Bracket
USC-1000	Universal System Controller - Provides Logging and Remote Notifications
TG-CAM-1010	Network Camera - Provides Snapshot Images and Video Recordings

Additional accessories and warning devices are available from Trigg Industries LLC.
Contact sales@triggindustries.com for details.

SPECIFICATIONS

**MODEL # PMB-500
POLE MOUNT BRACKET**

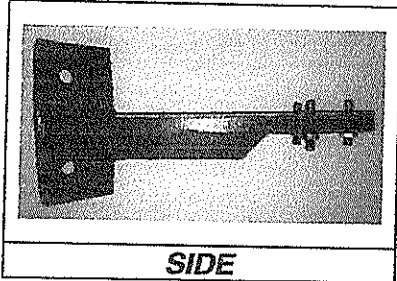

SIDE

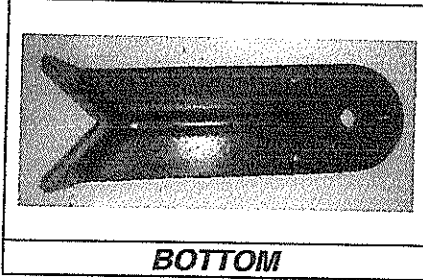

BOTTOM

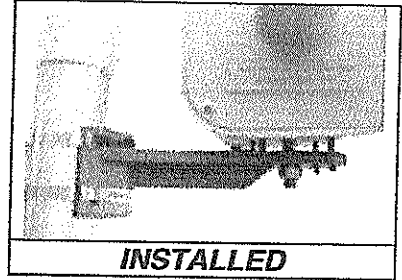

INSTALLED

ADJUSTMENT	Pan 270°, Pitch ± 15°, Roll ± 25°
DIMENSIONS	5 H X 3.5 W X 11 L inch (13 H X 9 W X 28 L cm)
CONSTRUCTION	Heavy ALMAG casting
FINISH	Light gray enamel
ATTACHMENT	Stainless steel bands or customer provided bolts. Adapts to any pole ≥ 3 inches diameter.
SHIPPING WEIGHT	2.5 lbs (1.2 kg) each. Two required per system.

LED SignLITE Signs

Sign LITE Warning System

*Easy to fit to existing sign, no AC required,
\$ 0.00 cost to operate.*

Description

Rigid aluminum structure with reinforced steel corners mounts to standard traffic sign with either 3M VHB tape or self tapping screws. LED warning system is embedded in weather tight epoxy. Hi visibility Luxeon Rebel LED's feature lens to greatly increase viewing distance. NEMA Enclosure to house Battery, Charge & Flash Control. Solar Panel and Pole Mount Hardware . Solar power allows installation where no power line is available.



Luxeon Rebel LED's

8 x 110 Lumen Luxeon Rebel Amber LED's
Total Luminous Flux = 880 lumen.
Viewing Angle 30 degrees
Luminous Intensity @ 4 feet = 110 Fc.
Meets SAE Standard J595.
Increased visibility at greater distance.

Most Common Sign Types :

- W11-2, Pedestrian Crossing
- Reduce Speed Ahead
- W3-3, Signal Ahead
- W12-2, Overheight "X"

ELECTRICAL

Enclosure with Flanges for pole mounting.
Includes Strobe2 Power Supply.
7 Selectable Flash Patterns.
(Flash Rate 55 fpm. Single Pulse DC standard, AC available).
20 Watt Solar Panel .
12 Amp Charge Controller.
15 Ahr Rechargeable Battery.

PHYSICAL

Sign - 3M Diamond Grade Reflective Sheet (FYG or YEL)
on Aluminum 0.08 Type 5052.
Light Channel - Extruded Aluminum 6105-T5.
Steel Reinforced corners.
3M VHB (Very High Bond) Tape.
(8) 6-32 x 3/8" Self Tap S/S Mounting Screws.
Light Channel Color - Black.
LED's embedded in UV resistant Clear Epoxy.>200 deg.F.
Weather tight to IP68.

30 in. Sign , Weight 8 lbs.

Dimensions : 30" x 30" x 1/2"D.

36 in. Sign , Weight 10 lbs.

Frame Dimensions : 36" x 36" x 1/2"D.

3 Year warranty (SignLITE), 1 Year (Battery).



LED SignLITE Signs

SOLAR 24 / 7 PACKAGE

Allows round the clock operation for 24 hrs / 7 day .

SOLAR TIME CLOCK PACKAGE

Turns sign on based on Time Clock program hours.

SOLAR PUSHBUTTON or SmartWALK SENSOR INPUT PACKAGE

Turns sign on for user selectable period when input is sensed from either Pedestrian pushbutton, detector or other input.

(PB or Sensor not included)

SYNC OPTION

Allows two signs (usually on opposite sides of street) to turn on together upon one being activated.

AC POWER OPTION

AC/DC power supply provided for AC line operation.

* Post or Pole not included.



Solar Panel - Sunwize or equal OEM Series.

Solar Panel Side of pole Mount.

Control Housing / Cabinet.

Charge Controller - Morningstar

Battery - Universal Battery or Deka

Timer Relay - Fuji or Seco

Flasher / Strobe - M-SYSTEMS INC.

Power Supply - Meanwell.

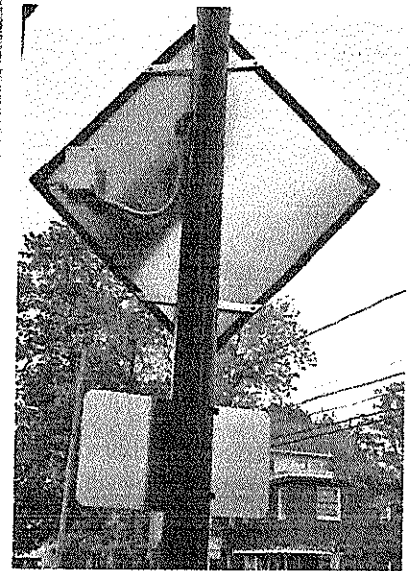

Type S1-1



**MOUNTING
EXAMPLE A**



**MOUNTING
EXAMPLE B**

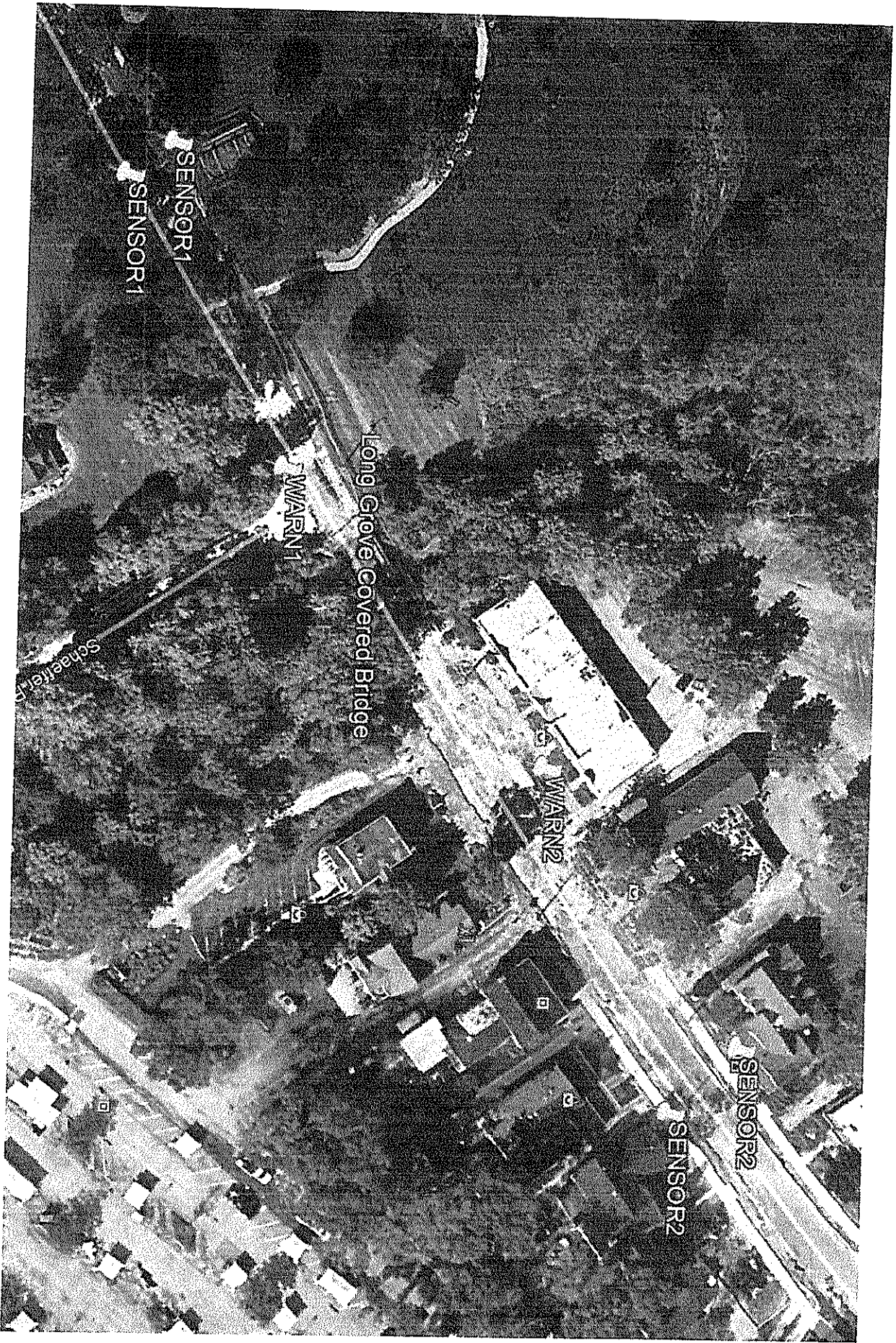



Scott Hoyne <hoynes50@gmail.com>

**Trigg Quote # 2021-041 - Covered Bridge (Long Grove, IL) - Over Height
Detection System**

Scott Hoyne <hoynes50@gmail.com>
To: petem@ht-electric.com

Mon, Mar 15, 2021 at 12:54 PM

Nice talking to you Pete, attached is the quote. Please confirm receipt. Thanks, Scott Hoyne, 847-404-1316
[Quoted text hidden]

3 attachments

 **TRIGG SPECS 2021-041.pdf**
1071K

 **TRIGG QUOTE 2021-041.pdf**
276K

 **Signage examples.pdf**
238K